



carbatec®

10" Bandsaw

BS-245H MANUAL

CARBATEC.COM.AU

1 YEAR
WARRANTY

THANK YOU FOR CHOOSING carbatec®

Carbatec has been a trusted brand for woodworking enthusiasts and professionals across Australia and New Zealand, since 1987.



Our quality woodworking products are designed and built to offer value and performance, making the latest features and technological advancements more accessible to Aussie woodworkers.

Backed by our no-fuss after-sales care and warranty support, you can trust Carbatec to keep you woodworking, as promised.

We look forward to sharing in your woodworking journey!

If you have any questions about our products or service, please call us on **1800 658 111** or email us at **info@carbatec.com.au**

Find us on social media

-  facebook.com/Carbatec
-  instagram.com/Carbatec
-  youtube.com/CarbaTecToolsForWood

WHAT'S IN THE BOX

The following items are provided in the shipping box:

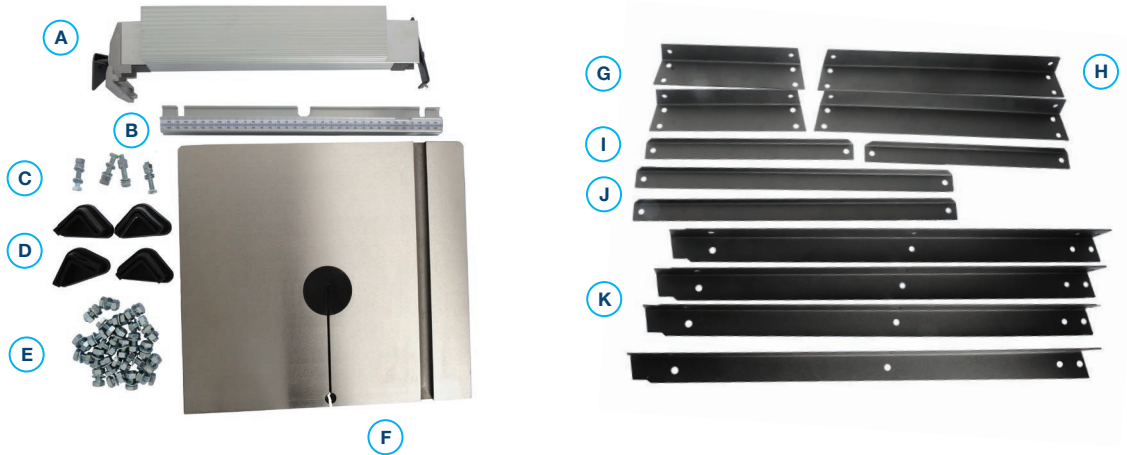

BS-245H 10" BANDSAW

- A. Fence
- B. Fence rail
- C. Main unit mounting bolts
- D. Feet
- E. Stand fasteners
- F. Cast table
- G. Short top brace
- H. Long top brace
- I. Short mid rail brace
- J. Long mid rail brace
- K. Legs

This bandsaw will require a minimal amount of assembly.

1. Remove parts from all of the cartons and lay them on a clean work surface.
2. Remove any protective materials and coatings from all of the parts and the bandsaw. The protective coatings can be removed by spraying WD-40 on them and wiping it off with a soft cloth. This may need to be redone several times before all of the protective coatings are removed completely.
3. Compare the items below to verify that all items are accounted for before discarding the shipping box.

CAUTION

DO NOT USE ACETONE, gasoline or lacquer thinner to remove any protective coatings.

WARNING

If any parts are missing, do not attempt to plug in the power cord and turn "ON" the bandsaw. The bandsaw can only be turned "ON" after all the parts have been obtained and installed correctly.

IMPORTANT

DUST COLLECTION: All woodworking machines require effective dust extraction to ensure quality work and longevity of the machine itself. Failure to connect your machine to a suitable dust collector may affect your warranty. The collector required for your machine will depend on several factors including the type of machine and its dust port connection, distance between collector and machine, type & frequency of use and the material being worked. We recommend a dust collector that will provide you a minimum airflow of 500-CFM when measured at the machine connection.

4

Key information can be found on the inspection panel, found on the rear of the machine.



QUALITY INSPECTED

| |
|-------------|
| Model: |
| Voltage |
| Freq: |
| Phase: |
| Amp: |
| kW: |
| Speed: |
| Lot No.: |
| Serial No.: |
| Date: |

Made in for:
CARBATEC PTY LTD
 Brisbane - Australian





Record the serial number and date of purchase in your manual for future reference.

SERIAL NUMBER:

.....

DATE OF PURCHASE:

.....

CONTENTS

| | |
|----------------------------------|-------|
| Introduction | 2 |
| What's in the box | 3 |
| Key information | 4 |
| Safety instructions - General | 6-9 |
| Safety instructions - Bandsaw | 10-11 |
| Safety instructions - Electrical | 12 |
| Overview | 13 |
| Specifications | 14 |
| Assembly | 15-23 |
| Changing the saw blades | 24-25 |
| Operation | 25-28 |
| Replacement blades | 29 |
| Maintenance | 30 |
| Wiring diagram | 31 |
| Warranty | 34 |
| Troubleshooting | 35 |

NOTE: The specifications, photographs, drawings and information in this manual represent the current machine model when the manual was prepared. Changes and improvements may be made at any time, with no obligation on the part of Carbatec to modify previously delivered units. Reasonable care has been taken to ensure that the information in this manual is correct, to provide you with the guidelines for the proper safety, assembly and operation of this machine.

SAFETY INSTRUCTIONS

IMPORTANT! Safety is the single most important consideration in the operation of this equipment. The following instructions must be followed at all times. Failure to follow all instructions listed below may result in electric shock, fire, and/or serious personal injury. There are certain applications for which this tool was designed. We strongly recommend that this tool not be modified and/or used for any other application other than that for which it was designed. If you have any questions about its application, do not use the tool until you have contacted us and we have advised you.

The purpose of safety symbols is to attract your attention to possible dangers. The safety symbols and the explanations with them deserve your careful attention and understanding. The symbol warnings do not, by themselves, eliminate any danger. The instructions and warnings they give are no substitutes for proper accident prevention measures.



WARNING

Be sure to read and understand all safety instructions in this manual, including all safety alert symbols such as “**DANGER**,” “**WARNING**,” and “**CAUTION**” before using this tool. Failure to following all instructions listed below may result in electric shock, fire, and/or serious personal injury.

SYMBOL MEANING



A safety alert symbol Indicates **DANGER**, **WARNING**, or **CAUTION**. May be used in conjunction with other symbols or pictographs.



DANGER

Indicates an imminently hazardous situation, which, if not avoided, will result in death or serious injury.



WARNING

Indicates a potentially hazardous situation, which, if not avoided, could result in death or serious injury.



CAUTION

Indicates a potentially hazardous situation, which, if not avoided, could result in minor or moderate injury.



NOTICE

(Without Safety Alert Symbol) Indicates a situation that may result in property damage.



Carbatec products bearing the Regulatory Compliance Mark (RCM) have been tested in accordance with applicable Australian/New Zealand Standards to ensure their compliance with all mandatory standards and regulations (applicable at time of original sale). Carbatec Pty Ltd are registered as a responsible supplier with relevant Australian government departments and our products are registered on the EESS & ACMA database.

GENERAL SAFETY

Operating a power tool can be dangerous if safety and common sense are ignored. The operator must be familiar with the operation of this machine. Read this manual to understand this machine. **DO NOT** operate this machine **IF YOU DO NOT FULLY UNDERSTAND** the limitations of this tool. **DO NOT MODIFY** this machine in any way.

BEFORE USING THIS MACHINE

WARNING

To avoid serious injury and damage to the tool, read and follow all of the Safety and Operating Instructions before operating the machine.

WARNING

1. SOME DUST CREATED BY USING POWER TOOLS CONTAINS CHEMICALS known to cause cancer, birth defects, or other reproductive harm. Some examples of these chemicals are:

- Lead from lead-based paints.
- Crystalline silica from bricks, cement, and other masonry products.
- Arsenic and chromium from chemically treated lumber

Your risk from these exposures varies, depending on how often you do this type of work. To reduce your exposure to these chemicals: work in a well ventilated area and work with approved safety equipment, such as those dust masks that are specially designed to filter out microscopic particles.

- 2. READ** this entire manual. **LEARN** how to use the tool for its intended applications.
- 3. GROUND ALL TOOLS.** If the tool is supplied with a 3-prong plug, it must be plugged into a 3-contact electrical receptacle. The 3rd prong is used to ground the tool and provide protection against accidental electric shock.
- 4. AVOID A DANGEROUS WORKING ENVIRONMENT.** Do not use electrical tools in a damp environment or expose them to rain.
- 5. DO NOT USE** electrical tools in the presence of **FLAMMABLE** liquids or gasses.
- 6. ALWAYS KEEP THE WORK AREA CLEAN,** well lit, and organized. Do not work in an environment with floor surfaces that are slippery from debris, grease, and wax.
- 7. KEEP VISITORS AND CHILDREN AWAY.** Do not permit people to be in the immediate work area, especially when the electrical tool is operating.
- 8. DO NOT FORCE THE TOOL** to perform an operation for which it was not designed. It will do a safer and higher quality job by only performing operations for which the tool was intended.

GENERAL SAFETY

- 9. WEAR PROPER CLOTHING.**
Do not wear loose clothing, gloves, neckties, or jewellery. These items can get caught in the machine during operations and pull the operator into the moving parts. The user must wear a protective cover on their hair, if hair is long, to prevent it from contacting any moving parts.
- 10. CHILDPROOF THE WORKSHOP AREA**
by removing switch keys, unplugging tools from the electrical receptacles, and using padlocks.
- 11. ALWAYS UNPLUG THE TOOL FROM THE ELECTRICAL RECEPTACLE**
when making adjustments, changing parts or performing any maintenance.
- 12. KEEP PROTECTIVE GUARDS IN PLACE AND IN WORKING ORDER.**
- 13. AVOID ACCIDENTAL STARTING.** Make sure that the power switch is in the “OFF” position before plugging in the power cord to the electrical receptacle.
- 14. REMOVE ALL MAINTENANCE TOOLS**
from the immediate area prior to turning “ON” the machine.
- 15. USE ONLY RECOMMENDED ACCESSORIES.** Use of incorrect or improper accessories could cause serious injury to the operator and cause damage to the tool. If in doubt, check the instruction manual that comes with that particular accessory.
- 16. NEVER LEAVE A RUNNING TOOL UNATTENDED.** Turn the power switch to the “OFF” position. Do not leave the tool until it has come to a complete stop.
- 17. DO NOT STAND ON A TOOL.** Serious injury could result if the tool tips over, or you accidentally contact the tool.
- 18. DO NOT STORE ANYTHING ABOVE OR NEAR** the tool where anyone might try to stand on the tool to reach it.
- 19. MAINTAIN YOUR BALANCE.** Do not extend yourself over the tool. Wear oil resistant rubber soled shoes. Keep floor clear of debris, grease, and wax.
- 20. MAINTAIN TOOLS WITH CARE.** Always keep tools clean and in good working order. Keep all blades and tool bits sharp, dress grinding wheels and change other abrasive accessories when worn.
- 21. EACH AND EVERY TIME, CHECK FOR DAMAGED PARTS PRIOR TO USING THE TOOL.** Carefully check all guards to see that they operate properly, are not damaged, and perform their intended functions. Check for alignment, binding or breaking of moving parts. A guard or other part that is damaged should be immediately repaired or replaced.
- 22. DO NOT OPERATE TOOL WHILE TIRED, OR UNDER THE INFLUENCE OF DRUGS, MEDICATION OR ALCOHOL.**

- 23. SECURE ALL WORK.** Use clamps or jigs to secure the work piece. This is safer than attempting to hold the work piece with your hands.
- 24. STAY ALERT, WATCH WHAT YOU ARE DOING, AND USE COMMON SENSE WHEN OPERATING A POWER TOOL.** A moment of inattention while operating power tools may result in serious personal injury.
- 25. ALWAYS WEAR A DUST MASK TO PREVENT INHALING DANGEROUS DUST OR AIRBORNE PARTICLES,** including wood dust, crystalline silica dust and asbestos dust. Direct particles away from face and body. Always operate tool in well ventilated area and provide for proper dust removal. Use dust collection system wherever possible. Exposure to dust may cause serious and permanent respiratory or other injury, including silicosis (a serious lung disease), cancer, and death. Avoid breathing dust, and avoid prolonged contact with dust. Allowing dust to get into your mouth or eyes, or lay on your skin may promote absorption of harmful material. Always use properly fitting AS/NZS approved respiratory protection appropriate for the dust exposure, and wash exposed areas with soap and water.
- 26. USE A PROPER EXTENSION CORD IN GOOD CONDITION.** Use of extension cords should be avoided where possible. When using an extension cord, be sure to have a cord heavy enough to carry the current your product will draw, and with compatible pin configuration and connections (NEVER use an extension cord rated at less than your machine). Longer run extensions will need heavier duty extension cords. Only connect your extension cord or machine to a receptacle that accepts your plug and never modify your plug to suit a receptacle.

SPECIFIC BANDSAW SAFETY

NOTE: According to the applicable product liability law the manufacturer of this device is not liable for damages which arise on or in connection with this device in case of:

- Improper handling
- Non-compliance with the instructions for use
- Repairs by third party, non authorised skilled workers
- Installation and replacement of non-genuine spare parts
- Improper use

RECOMMENDATIONS:

- Read the entire text of the operating instructions prior to the assembly and operation of the device. These operating instructions are intended to make it easier for you to get familiar with your device and utilise its intended possibilities of use.
- The operating instructions contain important notes on how to work safely with your machine and how to avoid dangers, and increase the reliability and working life of the machine.
- Retain and store these instructions near the machine. The instructions must be read and carefully observed by each operator prior to starting the work.
- In addition to the safety notes contained in the present operating instructions and the special regulations of your country, the generally recognised technical rules for the operation of wood working machines must be observed.



The device and packaging materials are not toys! Children must not be allowed to play with plastic bags, film and small parts! There is a risk of swallowing and suffocation!

INTENDED USE

- The machine must only be used in technically perfect condition in accordance with its designated use and the instructions set out in the operating manual, and only by safety-conscious persons who are fully aware of the risks involved in operating the machine. Any functional disorders, especially those affecting the safety of the machine, should therefore be rectified immediately. The safety, work and maintenance instructions of the manufacturer as well as the technical data given in the calibrations and dimensions must be adhered to.
- Relevant accident prevention regulations and other, generally recognised safety-technical rules must also be adhered to.
- The machine may only be used, maintained, and operated by persons familiar with it and instructed in its operation and procedures. Arbitrary alterations to the machine release the manufacturer from all responsibility for any resulting damages.
- The machine may only be used with original accessories and tools made by or recommended by the manufacturer.

- Any other use exceeds authorisation. The manufacturer is not responsible for any damages resulting from unauthorized use; risk is the sole responsibility of the operator.
- Saw dust and wood chips can be hazardous. Always wear AS/NZS approved personal protective gear such as safety goggles, dust mask and hearing protection.

SAFETY FOR BANDSAWS

- This bandsaw is intended for use in dry conditions, and for indoor use only.
- Do not cut pieces of material too small to hold by hand outside the blade guard.
- Avoid awkward hand positions where a sudden slip could cause a hand to move into the blade.
- Always use the blade guard to avoid possible injury due to blade breakage.
- Never leave the work area with the power connected, or before the machine has come to a complete stop.
- Do not perform layout, assembly or set up work on the table while the cutting tool is in operation.
- Never turn your bandsaw on before clearing the table of all objects: (tools, scraps of wood, etc) except for the workpiece and related feed or support devices for the operation planned.
- The use of incorrect or damaged mains cables can lead to injuries caused by electricity.
- Even when all safety measures are taken, some remaining hazards which are not yet evident may still be present.
- Remaining hazards can be minimised by following the instructions in Safety Precautions, Proper Use and in the entire operating manual.
- Do not force the machine unnecessarily: excessive cutting pressure may lead to rapid deterioration of the blade and a decrease in performance in terms of finish and cutting precision.
- Avoid accidental starts: do not press the start button while inserting the plug into the socket.

REMAINING HAZARDS

The machine has been built using modern technology in accordance with recognised safety rules. Some remaining hazards, however, may still exist.

- Long hair and loose clothing can be hazardous when the work piece is rotating. Wear personal protective gear such as a hair net and tight fitting work clothes.

ELECTRICAL SAFETY



WARNING

This tool must be grounded while in use to protect the operator from electric shock.

IN THE EVENT OF A MALFUNCTION OR BREAKDOWN, grounding provides the path of least resistance for electric current and reduces the risk of electric shock. This tool may be equipped with an electric cord that has an equipment grounding conductor and a grounding plug. The plug **MUST BE PLUGGED INTO A MATCHING ELECTRICAL RECEPTACLE** that is properly installed and grounded in accordance with **ALL** local codes and ordinances.

DO NOT MODIFY THE PLUG PROVIDED.

If it will not fit the electrical receptacle, have the proper electrical receptacle installed by a qualified electrician.

IMPROPER ELECTRICAL CONNECTION of the equipment grounding conductor can result in risk of electric shock. The conductor with the green insulation (with or without yellow stripes) is the equipment grounding conductor. **DO NOT** connect the equipment grounding conductor to a live terminal if repair or replacement of the electric cord or plug is necessary.

CHECK WITH A QUALIFIED ELECTRICIAN

or service personnel if you do not completely understand the grounding instructions, or if you are not sure the tool is properly grounded.

Use only a 3-wire extension cord that has a 3-prong grounding plug and a 3-pole receptacle that accepts the tool's plug. Replace a damaged or worn cord immediately.

Power tools and machinery are intended for use on a circuit that has an electrical receptacle as shown in **FIGURE A** that shows a 10 Amp 3-wire electrical plug and corresponding electrical receptacle that has a grounding conductor.

If this particular tool has been designed and fitted with a two prong electrical plug, ensure it displays the 'Double Insulated' logo shown in **FIGURE B**, before connecting to a 3-wire receptacle.



WARNING

Never modify the standard fitted electrical plugs to fit your receptacle.



OVERVIEW

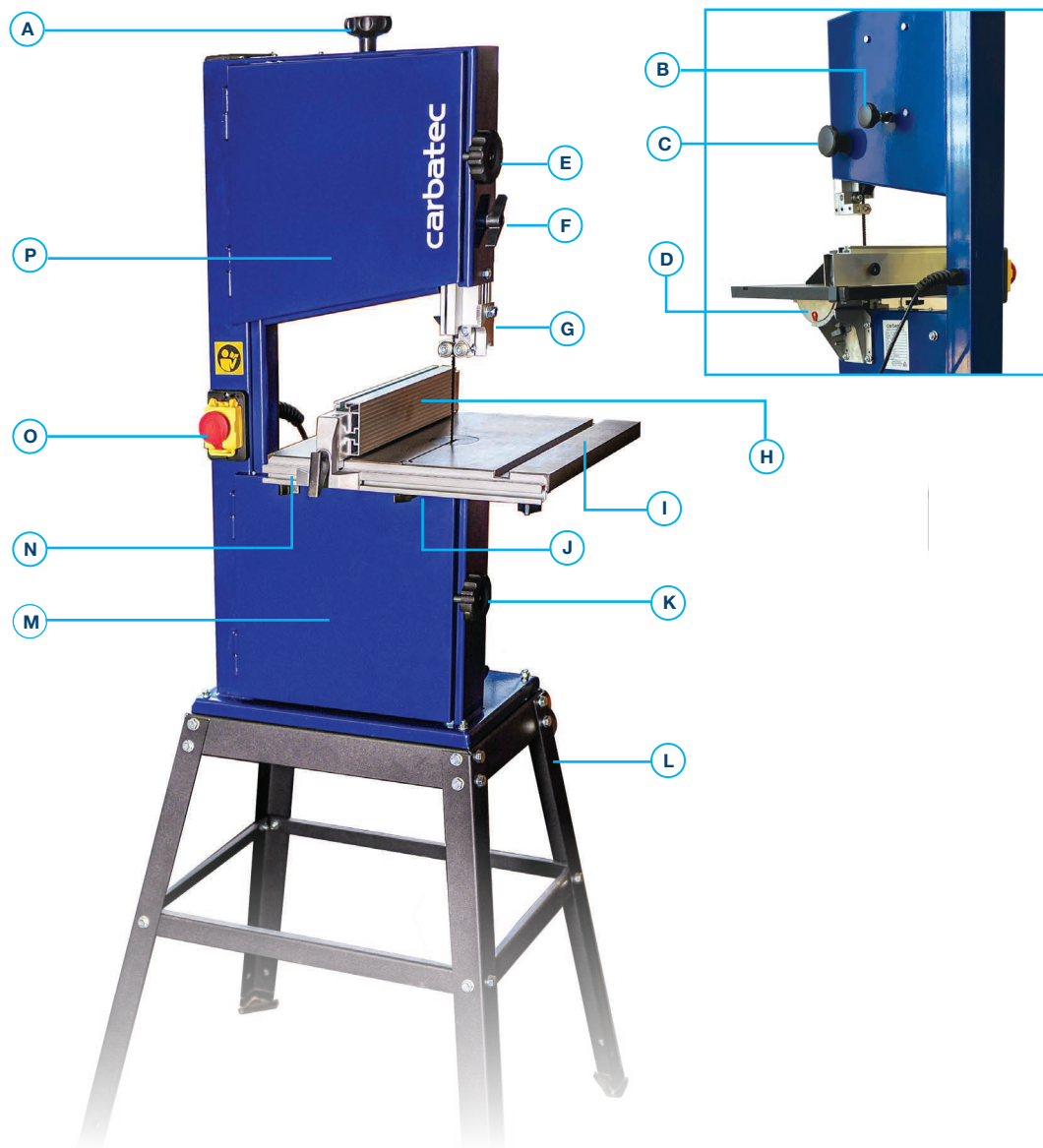

10" BANDSAW OVERVIEW

- | | |
|---------------------------------|------------------------------|
| A. Blade tension knob | I. Cast table |
| B. Blade tracking knob | J. Bottom blade guide |
| C. Blade guard knob | K. Bottom door lock |
| D. Table tilt trunnion | L. Stand |
| E. Top door lock | M. Bottom access door |
| F. Blade guard lock knob | N. Fence rail |
| G. Top blade guide | O. On/Off switch |
| H. Fence | P. Top access door |

SPECIFICATIONS

| | |
|-----------------------------------|---|
| BRAND | Carbatec |
| MOTOR | 375W (1/2HP) induction - Regular 10 Amp plug |
| SWITCH TYPE | Magnetic NVR |
| BLADE LENGTH | 1790mm |
| BLADE GUIDES | Ball bearing with manual rise and fall |
| BLADE RELEASE | Standard tension release |
| CUT DEPTH | 125mm |
| DUST PORT | 1x63.5mm (2.5") |
| MINIMUM BLADE WIDTH | 3.2mm (1/8") |
| MAXIMUM BLADE WIDTH | 10mm |
| MAXIMUM RIP CAPACITY | 245mm |
| POSITIVE STOPS | 0° adjustable |
| TABLE HEIGHT | 370/1010mm |
| TABLE SIZE | 330mm x 350mm |
| TABLE TILT | 0°- 45° |
| WORKSHOP FOOTPRINT (WxDxH) | 630mm x 480mm 1500mm |
| WHEEL DIAMETER | 255mm |
| WHEEL TYPE | Cast Alloy |
| WARRANTY PERIOD | 1 year |
| SHIPPING WEIGHT | 51Kg |
| NETT WEIGHT | 47Kg |

ASSEMBLY INSTRUCTIONS

NOTE: When assembling this leg stand do not tighten the nuts and bolts until the assembly is complete.

A. STAND ASSEMBLY

1. Using any one of the 4 legs, secure it to one of two long top braces with 2x short dome head bolt, washer and nuts.

Fig. A1

2. Attach opposite leg in the same way, with dome head bolt, washer & nuts

Fig. A2

3. Locate and attach the longest mid rail brace, and attach between the leg sections approx half way down, with a single dome head bolt, washer & nut on each leg.

Fig. A3

4. Repeat steps 1-3 to assemble the two remaining legs with long top rail and long mid rail brace in the same way.



STAND ASSEMBLY

5. Use one preassembled leg section. Attach the 2 shorter top braces with 4x dome head bolts, washers and nuts.

Fig. A4

6. Attach the 2 short mid rail braces with 2x dome head bolts, washers and nuts.

Fig. A5

7. Finally, attach the other preassembled leg section, to the rest of the frame using the 4x dome head bolts, washers and nuts at the top of the stand, and 2x at the mid rail.

Fig. A6

8. Turn the stand upright and check for completeness. Again, ensure the nuts are only loosely tightened at this stage.

Fig. A7



FITTING TO THE STAND

B. FITTING THE BANDSAW TO THE STAND

1. Push the 4x rubber feet on to the bottom of the stand legs.

Fig. B1



2. From under the top of the stand frame, put the 4x long hex bolts through the stand top (in each of the 4 corners), and fasten a nut onto each. Tighten these bolts & nuts prior to continuing.

Fig. B2

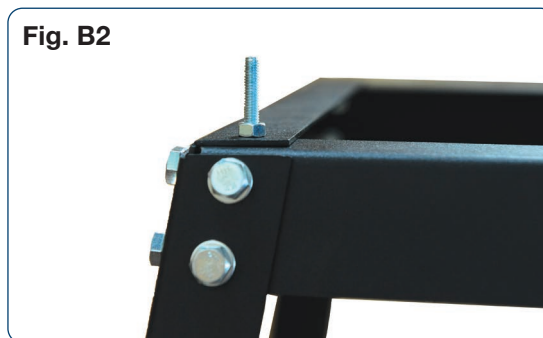

3. Place the stand on a flat stable surface.

Fig. B3



4. Carefully tilt the carton containing the main bandsaw body, to the upright position.

Fig. B4

5. Slide the main body and packaging out of the carton or carefully cut the carton off the packaging. Remove all remaining packaging and plastic protective cover.



CAUTION! The machine is heavy. Additional help or a suitable lifting device or support will be required for lifting the machine onto the stand.

FITTING TO THE STAND

! CAUTION

You may require assistance for the following step. Lift the main body up and onto the top of the stand. Be aware of the exposed bandsaw blade while lifting.

6. Take care to align the 4x protruding bolts on the stand, with the 4x holes on the base of the main bandsaw body.

Fig. B7

7. Using the 4x remaining wash and nuts, attach the main body to the stand, and tighten.

Fig. B8 & B9

8. At this stage, please ensure the entire unit is sitting level, and then proceed to tighten the 24x nuts on the stand itself.

NOTE: Check for any visible damage which may have occurred during transport. If a damage is detected notify your dealer immediately.

Fig. B7



Fig. B8



Fig. B9



FINAL ASSEMBLY

C. INSTALLING TO TRUNNION

1. Loosen the wing nut between the upper and lower trunnion, place into the horizontal position and re-tighten.

Fig. C1

2. Slide the cast iron table (smooth side up) onto the trunnion passing the blade through the table slot from the rear of the machine.

3. Align and attach the table to the upper trunnion with the 4x M6x12mm hex bolt and lock washers. Access to the inner rear holes may be simpler if you leave them till last, and tilt the table to the 45° position to give you better access.

Fig. C2 & C3

4. Place the blade tension knob onto the matching shaft on the top of the upper cabinet.

Fig. C4



FINAL ASSEMBLY

5. To fit the supplied fence, prepare the two smaller wing knobs and fit with a washer to the outer left and right holes situated under the front leading edge of the cast iron table. These should be fitted with sufficient gap to allow the fence rail to slot in.

Fig.C5



6. Slide the front fence rail onto the table, lining up with the two knobs fitted in previous step, and tighten.

Fig.C6

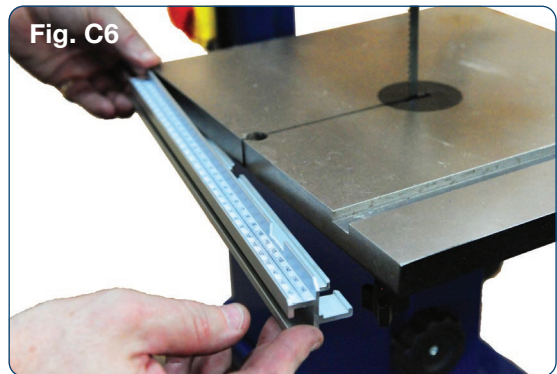

7. Pass the long tapered table alignment pin through the hole at the centre front of the table slot, and attach the kip lock lever to the underside and tighten.

Fig.C7

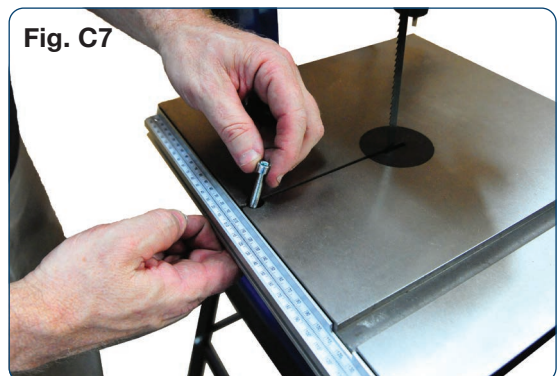

8. Attach the fence to the machine by rotating the front lever (in the unlocked position) to allow adequate clamping pressure between back of table and front fence rail when lever is in the locked position. The lever lock should be adjusted to allow simple lock/unlock without the need for adjustment.

Fig.C8



ALIGNMENT & ADJUSTMENTS



DANGER

ENSURE POWER IS DISCONNECTED FROM YOUR MACHINE BEFORE UNDERTAKING ANY ADJUSTMENTS OF ALIGNMENT.

D. SETTING BLADE TO TABLE SQUARENESS

Fig. D

1. With the blade tensioned adequately (see Changing Saw Blades p. 24), adjust the blade trunnion by loosening the large wing nut, and adjust the table so that it is exactly 90° to the blade. Use a good quality engineers square or other measuring device for accuracy.
2. Lock off the trunnion, and with a Phillips head screwdriver, adjust the red trunnion dial indicator as necessary, so it reads ZERO.

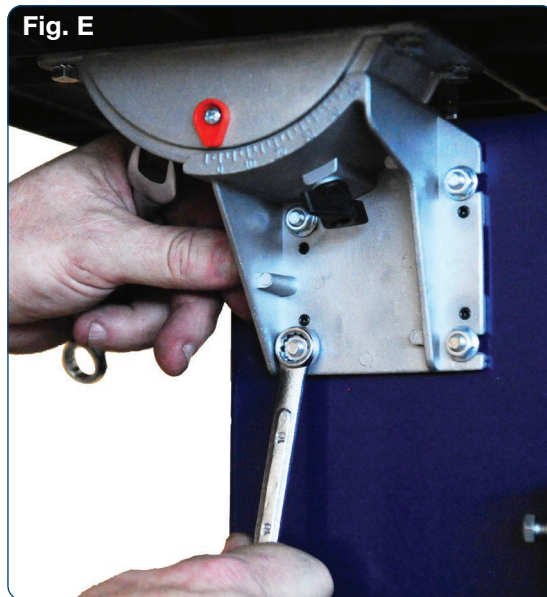
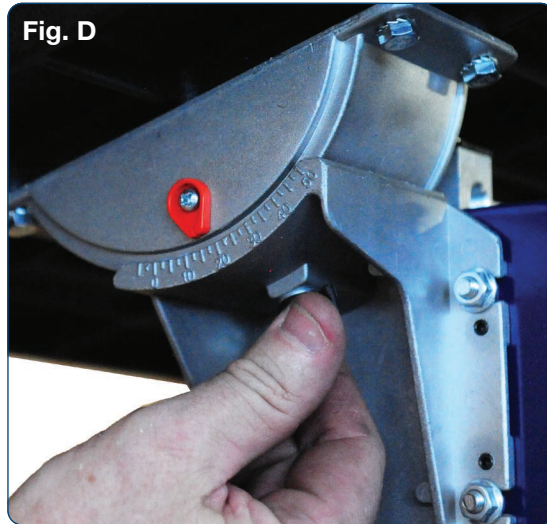

E. SETTING BLADE FENCE FOR PARALLEL

Fig. E

Setting blade to fence parallel is a process of trial and error. These adjustments can be carried out on the table to upper trunnion mounting points by slightly loosening, adjusting and re-tightening the table. This should also be checked after changing blades or adjusting blade tracking & tension (see Changing Saw Blades p. 24.)

NOTE: Take your time as the small adjustments here can make a big difference in your cuts, but also make the following adjustments much easier.

ALIGNMENT & ADJUSTMENTS

F. SETTING FENCE TO ZERO

1. Lock the fence so that it reads ZERO. If this position sees an excessive gap between fence and blade, or if the blade is pressing hard against the fence, proceed to adjust the fence position.
2. Loosen the four lower trunnion nuts (where it attached to the main body), to allow minor adjustment in fence to blade alignment. **Fig. F.** With this fence set to ZERO, you should aim to have the inside teeth of the blade barely contacting the fence.
3. Tighten the four lower trunnion nuts once you have set ZERO.

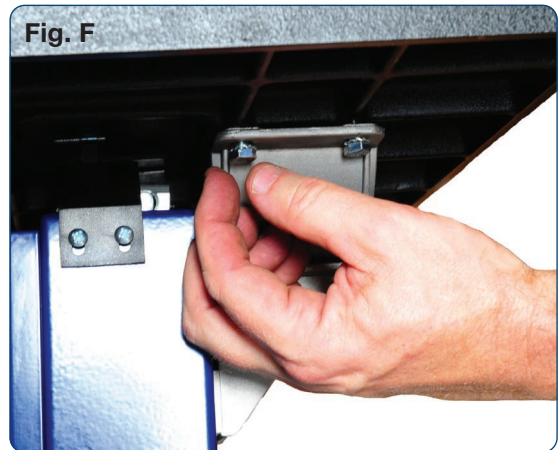

G. SETTING BLADE TRACKING

Blade tracking refers to setting the blade position where it rests on the wheel during operation. It is a combination of blade tension and wheel angle, and the two work together to give you straight cuts. Blade selection will also have an effect on blade tracking, with different blade widths requiring different tensions and wheel position. A general rule of thumb is that the body of your chosen saw blade (the solid part between the bottom of the blade gullet, and the back of the blade), should run approximately in the centre of the rubber wheel tyre.

With your saw turned OFF, blade tension is best checked by eye and feel (even if your bandsaw has a tension gauge). Varying blade lengths can cause tension gauges to give false tensions. A simple rule here is that regardless of blade width, your bandsaw blade should not deflect any more than 6mm with moderate pressure applied and with your guides set at approx 150mm from the table. For wider blades, and for deep resawing work, you may need to experiment with higher tension (or less blade deflection) and check your blade tracking accordingly.

1. Set your blade tension first using the tension knob on the top of the cabinet, then adjust top and bottom saw guide bearings, and thrust (rear) bearings, so that they are not in contact with the saw blade (see Adjusting Blade Guide Bearings, p.24).

Fig. G1



2. Open the upper and lower cabinet doors and rotate the upper wheel clockwise (towards you), watching the position of the blade on the upper wheel tyre.

3. To adjust the wheel position, loosen the large wing locking nut on the rear of the upper cabinet, and while hand turning the upper wheel, rotate the knurled adjustment knob clockwise or anticlockwise to change the angle of the top wheel and in turn the blade position on the wheel, remembering to continually turn the upper wheel as you adjust.

Fig. G2



4. Tighten the large wing locking knob when completed.
5. Check the blade to fence alignment and adjust as required.

CHANGING THE SAW BLADES

H. ADJUSTING BLADE GUIDE BEARINGS

1. Adjust the top and bottom blade guide bearings by loosening the hex screw and moving the bearing so that it is approx 0.05-0.1mm (one or two sheets of paper) away from the blade. Also adjust the rear thrust bearing so that it is just behind the rear of the blade without touching. Tighten all guides making sure not to move them while tensioning. Depending on your guide position, these may need adjustment between varying cuts.

Fig. H1

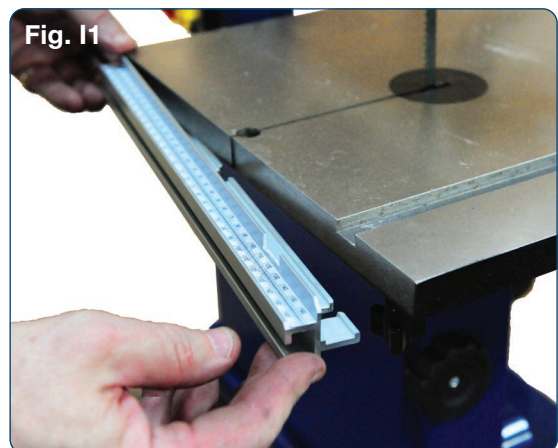
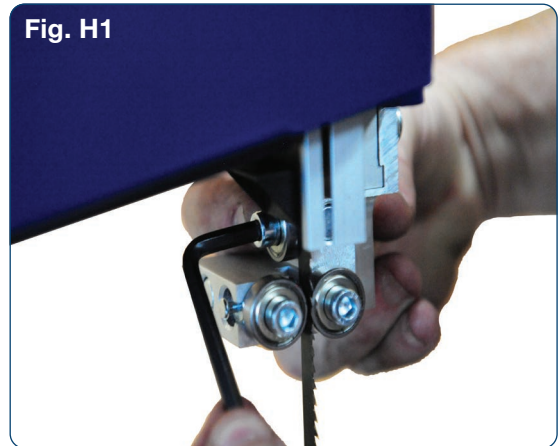

Fig. I1

I. CHANGING SAW BLADES

1. Remove the entire rip fence by releasing tension lever and lifting off. Loosen and remove the table alignment pin and kip lever, loosen the left/right fence mounting wing knobs and remove the fence rail.
2. Release blade tension using tension knob on top of cabinet.
3. Remove table infill plate (by pushing up from underneath if needed) and slide blade off top wheel, carefully maneuver blade through table slot and rear cabinet slot, and off of bottom wheel.

Fig. I2



OPERATION

Reverse this process to fit new blade, ensuring the blade teeth are facing forward, and teeth are pointing DOWN in your right hand.

4. Apply correct blade tension, and recheck tracking, alignment etc. as per instructions.
5. Refit the table infill and fence assembly and table alignment pin.

J. SETTING THE CUTTING HEIGHT

The upper blade guide should always be set as close as practical against the work. To adjust, loosen the wing nut at the side of the upper wheel housing, and set the blade guide to the required height. Tighten wing nut after setting.

Fig. J

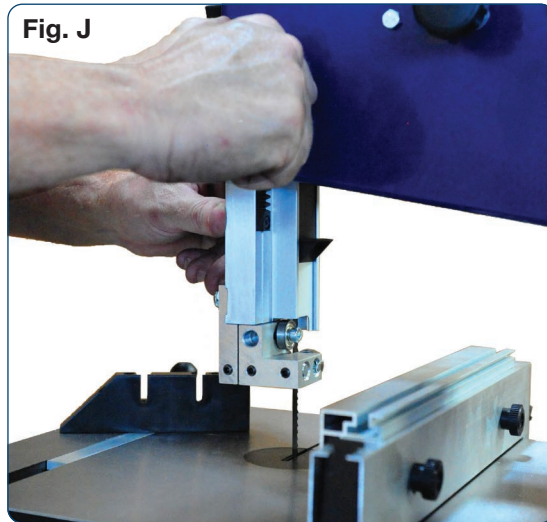
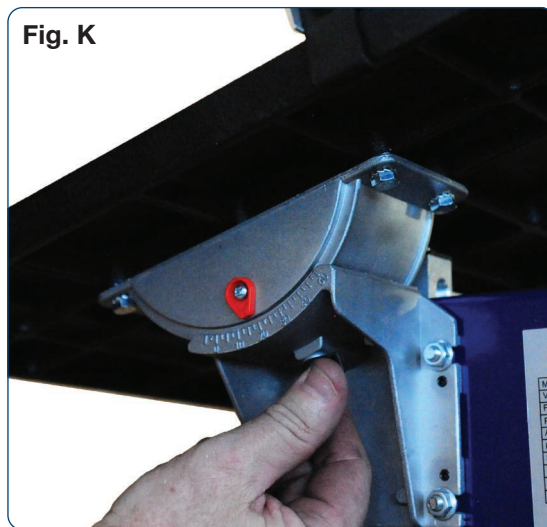

Fig. K



K. SAW TABLE TILT

1. For bevel cuts the saw table tilts steplessly through 45°. To tilt, loosen the wing nut on the table trunnions, set table to the required angle and tighten the wing nut again.

Fig. K

2. It is recommended to verify the correct angle setting by making trial cuts in scrap wood.

OPERATION

! CAUTION

Ensure you are wearing **AS/NZS approved PPE (dust mask or respirator, eye protection and hearing protection)**. Remember to avoid placing your hands anywhere near the cutting area, and make sure you have push sticks, push blocks in close proximity.

L. RIP CUTTING

Basic rip cutting operations are undertaken utilising the ripping fence, to set the distance between the blade and the fence (the ripping width).

1. Set the desired width by aligning fence to the markings on the included ripping guide (near the front of the fence), or by measuring between fence and blade, then lock the fence in position.

Fig. L1

2. Set and lock the blade guide to a height approximately 6mm above your workpiece and adjust both the blade tension bearing guides (upper and lower) as shown in the setup instructions.

Fig. L2

3. Start the machine, waiting until it is running at full speed, before presenting the timber to the blade.
4. Hold the timber positively against the fence, while then pushing the timber slowly forward into and through the blade. If the machine slows or labours under the load, slow your feeding speed to allow the machine to keep its blade speed as high as possible.

Fig L3

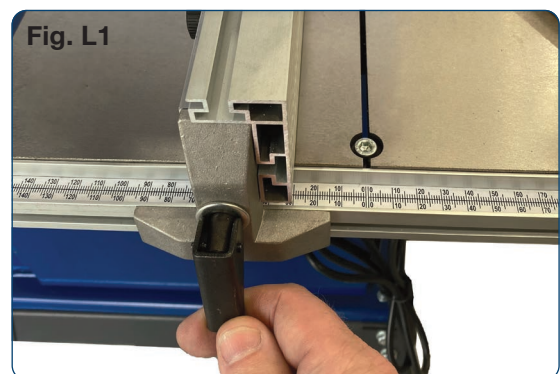

5. Continue feeding until your board is cut through. Controlling your cuts utilising feather boards will free up your hands, allowing you to safely reach around the rear to control the board exiting the blade.

Fig. L4

6. Rip cutting can also be done with the table tilted to the required angle (as shown in setup and adjustments). Ensure you follow these same principles for bandsaw setup and use.
7. Turn the bandsaw off immediately after completing your cut, and wait for the blade to come to a complete stop before making adjustments or reaching anywhere near the blade.

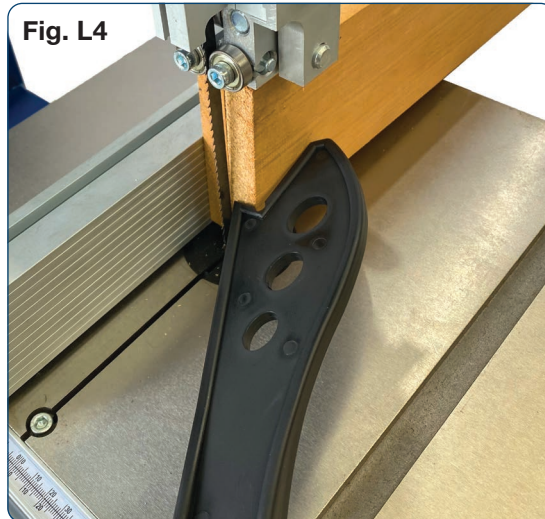

M. CURVE OR FREE HAND CUTTING

Curve cutting is usually done with the fence removed from the machine, or slid and locked out of the way. Ensure you have enough room to perform all your cuts before starting. Remember to avoid placing your hands anywhere near the cutting area, and make sure you have push sticks, push blocks in close proximity.

Curve cutting is usually performed with a predefined pattern or shape drawn onto your workpiece. A good practice is to clearly identify your waste material, from your good work, to avoid incorrectly placed cuts.

Depending on the radius of your curves, you may need to plan and perform several clearance cuts around and through your waste material. This will allow you to remove small sections so you may gain access to tighter areas.

1. Set and lock the blade guide to a height approximately 6mm above your workpiece and adjust both the blade tension bearing guides (upper and lower) as shown in the setup instructions.

OPERATION

2. Start the machine, waiting until it is running at full speed, before presenting the timber to the blade.
3. Slowly advance the timber to the required line to begin cutting, slowly turning the timber to follow your pattern.

Fig. M1

4. With smaller radius cuts, slow the feed speed down, and rotate the timber, watching and listening for excessive blade twist and burning. Retract or reverse the rotation and slowly nibble away at tight radius and complex corners.

Fig. M2

5. If you find yourself in a difficult cut where you cannot continue, don't force the work through but switch off your saw, wait for it to stop and manually removing or reverse the board from the cut.
6. Turn the bandsaw off immediately after completing your cut, and wait for the blade to come to a complete stop before making adjustments or reaching anywhere near the blade.
7. Complex curve cutting can also be done with the table tilted to the required angle (as shown in setup and adjustments). Ensure you follow these same principles for bandsaw setup and use.

Fig. M3

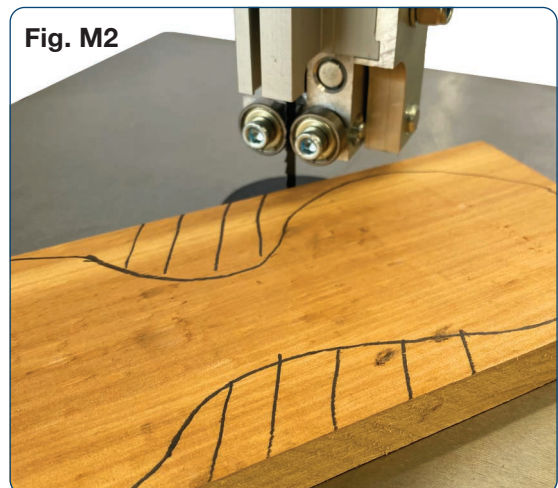
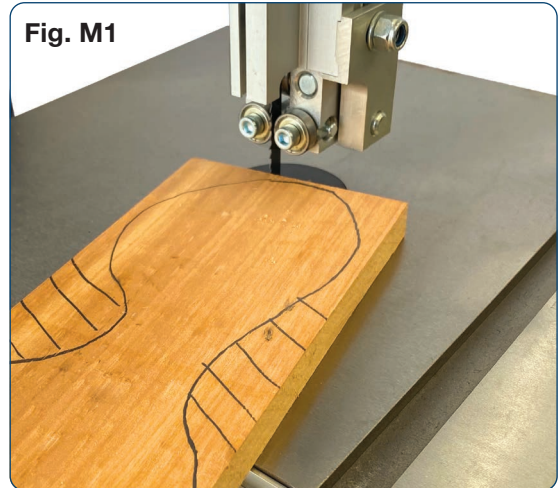

- 8. Miter cutting can be undertaken utilising the included miter gauge, set to the desired angle.
Fig. M4

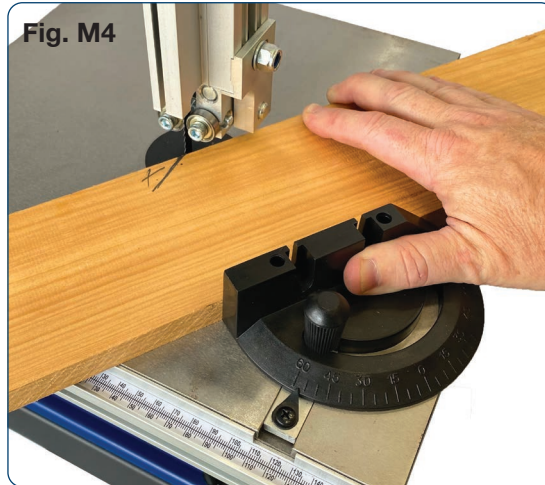

N. REPLACEMENT BLADES

| KEY No | LENGTH (mm) | WIDTH (mm) | TPI |
|---------------|-------------|------------|-----|
| BBL-1790-3-14 | 1790 | 3 | 14 |
| BBL-1790-6-6 | 1790 | 6 | 6 |
| BBL-1790-6-10 | 1790 | 6 | 10 |
| BBL-1790-10-6 | 1785 | 10 | 6 |

A 3mm x 14TPI blade will do very tight curves, in material up to approximately 12mm in thickness. It will leave a good edge, though will cut slowly.

The amount of Teeth Per Inch (TPI) relates directly with the thickness of timber it is capable of cutting. The fewer the amount of teeth, the more sanding will be needed to clean up the surface yet will cut quite quickly, and the more the teeth the cleaner the cut will be, yet will cut a lot slower. Thicker timber is going to require a blade with less teeth to cope with such a cut.

The width of the blade, which is measured from the back of the blade to the tip of the teeth, will determine the radius the blade is capable of cutting, the smaller the blade means the tighter the radius possible. Likewise, the larger the size, the more it is designed for ripping in straight lines and less capable of cutting arcs and curves, to the point where only straight cutting will be done.

MAINTENANCE

Maintenance of all woodworking machinery is important to keep them operating at their best, ensuring a long machine life, accurate machining and unexpected (or potentially dangerous) breakdowns.



WARNING

Start by turning the machine off, removing from the power source and prevent accidental restarting.

- If you have an air compressor, carefully blow any sawdust and other debris away from the band saw. Ensure you are wearing AS/NZS approved PPE (dust mask or respirator, eye protection and hearing protection).
- Remove rust from the cast iron table areas using a liquid rust remover, or other cleaning product (avoid silicone based products that may cause issues with wood finishes later on). Take a clean cloth to wipe any cleaning residue, dirt or dust off the table. When it's dry, apply a surface protectant. Carbatec offer many products for machine cleaning and care.
- Check the cutting edges of the blades and replace if dull. Thoroughly clean the blades clean with either steel wool or a firm bristle brush if they are rusty or pitch covered. Using a rust or pitch remover if required. Depending on the machine, it may be easier to remove the blade/s to do this. Clean any areas that hold or contact the blade (blade guides, tyres, blade seats, bearings and arbor etc). Replace worn components immediately.
- Check drive systems and drive belts or chains for wear or adjustment. Replace worn or cracked belts. If your machine has multiple belts, remember to change them all at the same time.
- Check all manual or automatic guards, doors, switches and machine interlocks for correct and safe operation. Replace as required.

WIRING DIAGRAM

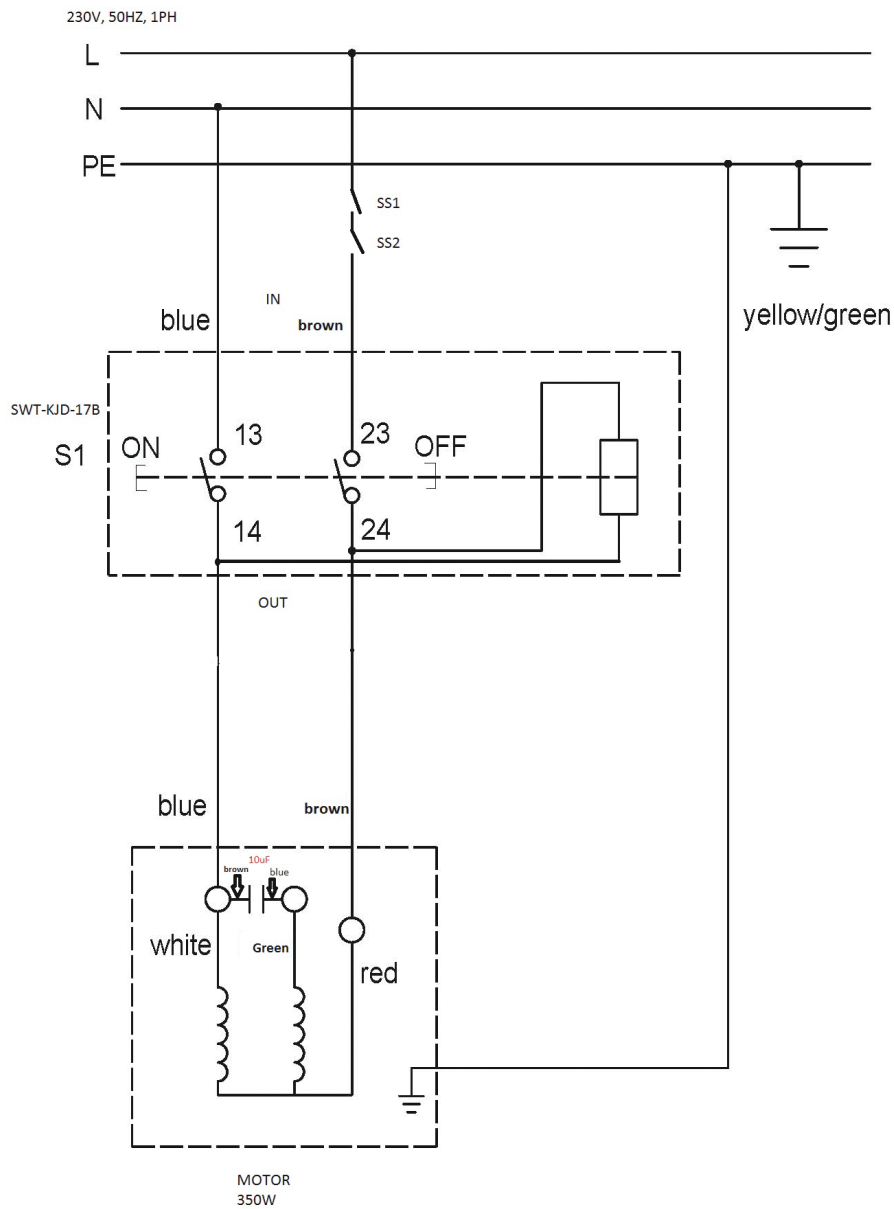

PARTS DIAGRAM

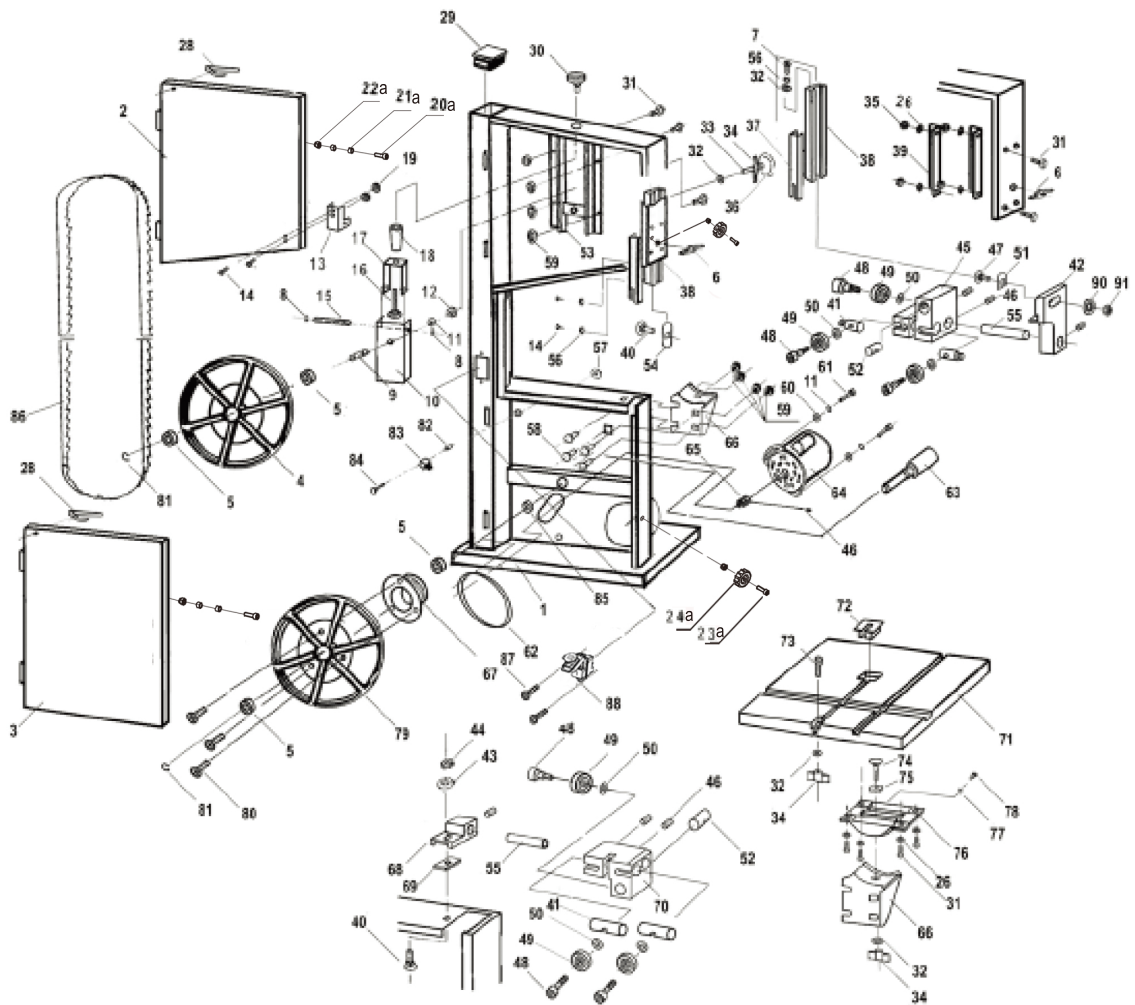

PARTS LIST

| KEY No | DESCRIPTION | KEY No. | DESCRIPTION | KEY No. | DESCRIPTION |
|--------|-------------------------------|---------|--------------------------------|---------|----------------------------|
| 1 | Band saw frame | 33 | Hex. screw | 62 | J-belt |
| 2 | Door upper | 34 | Wing nut | 63 | Bearing bolt lower |
| 3 | Door lower | 35 | Hex. nut | 64 | Motor |
| 4 | Upper wheel | 36 | Knurled thamb screw | 65 | Motor pulley |
| 5 | Bearing ball | 37 | Blade guard | 66 | Table trunnion lower |
| 6 | Wing nut | 38 | Roller guide carrier extrusion | 67 | Wheel pulley |
| 7 | Pan head tapping screw | 39 | Guide angle | 68 | Lower guide mount |
| 8 | Star lock cap | 40 | Carriage bolt | 69 | Pin guide seat |
| 9 | Bearing bolt upper | 41 | Adjusting shaft | 70 | Lower guide body |
| 10 | Wheel carrier bracket | 42 | Upper guide mount | 71 | Table |
| 11 | Spring washer | 43 | Washer | 72 | Table insert |
| 12 | Hex. nut | 44 | Preruling torque type hex nut | 73 | Hex. socket head cap screw |
| 13 | U-mount | 45 | 3-roller guide ass'y | 74 | Carriage bolt |
| 14 | Pan head screw | 46 | Screw socket set | 75 | Glide piece |
| 15 | Shaft mount | 47 | Carriage bolt | 76 | Table trunnion upper |
| 16 | Carriage bolt | 48 | Hexagon screw | 77 | Scale |
| 17 | Blade tensioner | 49 | Bearing ball | 78 | Pan head tapping screw |
| 18 | Blind rivet nut | 50 | Washer | 79 | Lower wheel |
| 19 | Preruling torque type hex nut | 51 | Bolt guide | 80 | Pan head cross screw |
| 20 a | Hex socket head cap screw | 52 | Mount shaft | 81 | Ring-retaining |
| 21 a | Bushing | 53 | Tension angle | 82 | Spacer bushing |
| 22 a | Lock nut | 54 | Bolt guide | 83 | Brush strip |
| 23 a | Hex socket head cap screw | 55 | Lower guide shaft | 84 | Carriage bolt |
| 24 a | Handle | 56 | Lockwasher extend | 85 | Hex. nut |
| 28 | Leaf spring | 57 | Hex. nut with flange | 86 | Blade |
| 29 | Lamello plug black | 58 | Carriage bolt | 87 | Pan head cross screw |
| 30 | Star knob | 59 | Hex. nut with flange | 88 | Lock switch |
| 31 | Hex. screw | 60 | Washer | 90 | Washer |
| 32 | Washer | 61 | Hex. socket head cap screw | 91 | Hex. nut |

1 YEAR WARRANTY

WARRANTY

- A. We warrant that this Carbatec product will be free from defects caused by faulty workmanship or faulty materials for a period of 1 year from date of sale.
- B. This warranty is in addition to other rights and remedies you may have under a law in relation to the goods.
- C. This warranty does not apply in any of the following cases:
- i. Defects arising from:
 1. fair wear and tear;
 2. corrosive atmosphere;
 3. damage or injury caused by deliberate act, lack of care or failure to comply with the recommended care and maintenance for the goods;
 4. improper use of the goods;
 5. alterations or repairs (not made by us) to the goods;
 - ii. defects arising from an event outside of our control such as fire, flood, earthquake or other natural calamity, motor vehicle or other accident, strike, civil unrest, terrorism or war;
 - iii. to accessory items such as after-market jigs, accessories or other items which are not sold or serviced by us and which are not sold with or were not included with the main unit purchased; or
 - iv. to wearable parts such as drive belts/shafts, bearings, bandsaw tyres, motor brushes, blades or abrasive belts/discs or other cutting or machining implements.
 - v. damage caused to any electrical component, where connected to a power supply outside the country for which it was designed (namely Australia or New Zealand).
- D. If this warranty applies and you have complied with the procedure below for making a claim, we will, at our election, either repair the goods (or those parts of the goods recognised as defective) or will provide a replacement within a reasonable time at our expense.
- E. If this warranty applies, the procedure for making a claim is:
- i. you must contact us by email;
 - ii. you must include in the email the following information:
 1. a copy of the order or receipt for the goods;
 2. the serial or batch number printed on the machinery manufacturing plate; and
 3. a detailed description of the fault and how and when it arose; and
 - iii. If the fault is a type covered by this warranty, we will then make arrangements with you for the return of the goods to us (for repair or replacement) at our cost using our transport providers or we may decide to attend at your premises to repair or replace the goods.
- F. Our liability (and that of our resellers) under this warranty is wholly limited to repair or replacement of the goods (or those parts of the goods recognised as defective) in accordance with the procedure above and you have no right to other compensation, costs or damages under this warranty. But this does not mean that you may not have other rights under a law in relation to the goods.
- G. If following our inspection of goods returned by you under this warranty it is found that this warranty does not apply and you are not otherwise entitled to repair or replacement by us, you must, if requested by us, reimburse our costs including parts, labour and freight.
- H. This warranty is not transferable and only the person who purchased the goods may make a claim.
- I. Where the goods have been exported outside Australia or New Zealand, the Company may not require the Purchaser to return any allegedly faulty or defective Product for evaluation. However, the Company has the right to request the return for evaluation at purchasers cost.

STATUTORY NOTICE

Our goods come with guarantees that cannot be excluded under the Australian Consumer Law. You are entitled to a replacement or refund for a major failure and for compensation for any other reasonably foreseeable loss or damage. You are also entitled to have the goods repaired or replaced if the goods fail to be of acceptable quality and the failure does not amount to a major failure.

TROUBLESHOOTING

TO PREVENT INJURY TO YOURSELF or damage to the bandsaw, turn the switch to the “OFF” position and unplug the power cord from the electrical receptacle before making any adjustments.

| PROBLEM | LIKELY CAUSE(S) | SOLUTION(S) |
|---|--|--|
| The machine does not work when switched on. | <ol style="list-style-type: none"> No power supply. Defective switch. | <ol style="list-style-type: none"> Check the cable for breakage. Check the fuse. Return machine to your local dealer for repair. |
| The blade does not move with the motor running. | <ol style="list-style-type: none"> The blade tension knob has not been tightened. The blade has come off one of the wheels. The saw blade has broken. The drive belt has snapped | <ol style="list-style-type: none"> Switch off the motor, tighten the blade tension knob. Open the hinged door and check. Replace the blade Replace the belt. |
| The blade does not cut in a straight line. | <ol style="list-style-type: none"> Fence for cutting not used. Too fast feed rate. The blade teeth are dull or damaged. Blade guides not suitably adjusted. | <ol style="list-style-type: none"> Use a fence. Put light pressure on the workpiece. Make sure the blade does not bend. Try a new blade. Adjust the blade guides (see assembly instructions). |
| The blade does not cut, or cuts very slowly. | <ol style="list-style-type: none"> The teeth are dull, caused by cutting hard material or long use. The blade was fitted the wrong way round. | <ol style="list-style-type: none"> Replace the blade, use a 6 T.P.I. blade for wood and soft materials. Use a 14 T.P.I. blade for harder materials. A 14 T.P.I. blade always cuts slower due to the finer teeth and the slower cutting performance. Fit the blade correctly. |
| Sawdust builds up inside the machine. | <ul style="list-style-type: none"> This is normal | <ul style="list-style-type: none"> Clean the machine regularly. Open the hinged door and remove the sawdust with a vacuum cleaner. |
| Sawdust inside the motor housing. | | <ul style="list-style-type: none"> Clean the ventilating slots of the motor with a vacuum cleaner. From time to time remove the sawdust to prevent it from being sucked into the housing. |
| The machine does not cut at 45° or 90° angles. | <ol style="list-style-type: none"> The table is not at right angles to the blade. The blade is dull or too much pressure was put on the workpiece. | <ol style="list-style-type: none"> Adjust the table. Replace the blade or put less pressure on the workpiece. |
| The blade cannot be properly positioned on the pulley. | <ol style="list-style-type: none"> The wheels are not in alignment. Defective bearing. The wheel alignment knob hasn't been properly adjusted. Inferior blade. | <ol style="list-style-type: none"> Return the machine to your local dealer for repair. Adjust the knob (see instructions). Replace the blade. |



Carbatec Pty Ltd

E info@carbatec.com.au

AU 1800 658 111

NZ 0800 444 329

128 Ingleston Road, Wakerley,
Queensland Australia 4154

ABN 84 010 706 242

CARBATEC.COM.AU

carbatec®

1 YEAR
WARRANTY